

INSTALLATION & USER'S MANUAL

DUCT TYPE

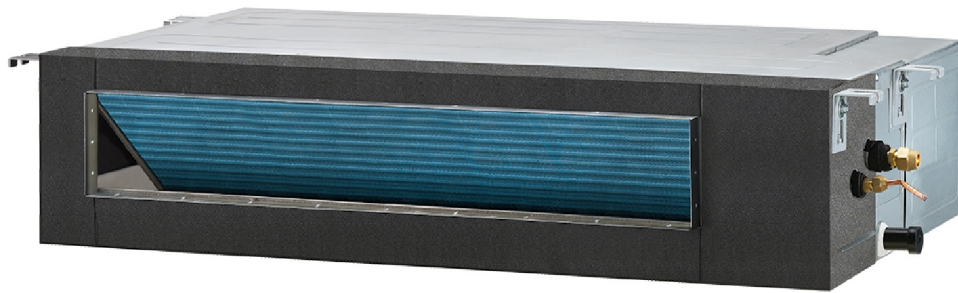

- Please read this installation manual carefully before installing your air conditioner.
- Please keep this manual in a safe place for future reference.
- This manual is suitable for cooling&heating, electric auxiliary heater unit .

CONTENTS

INSTALLATION MANUAL

ACCESSORIES	01
INSTALLATION OVERVIEW	02
INDOOR UNIT INSTALLATION	03
OUTDOOR UNIT INSTALLATION	09
DRAIN PIPE INSTALLATION	12
REFRIGERANT PIPE INSTALLATION	14
ELECTRICAL WIRING	19
AIR EVACUATION	22
TEST RUN	24

OWNER'S MANUAL



SAFETY PRECAUTIONS	25
PARTS AND FUNCTIONS	28
REMOVE CONTROLLER RECEIVER	30
MAINTENANCE	31
TROUBLESHOOTING	33
DISPOSAL GUIDELINE	37
INFORMATION SERVICING	38

INSTALLATION MANUAL

ACCESSORIES

NOTE :

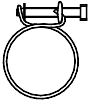
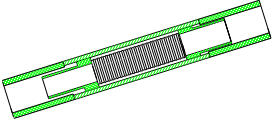
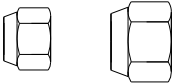
The air conditioning system comes with the following accessories. Use all of the installation parts and accessories to install the air conditioner. Improper installation may result in water leakage, electrical shock and fire, or cause the equipment to fail.

NAME	Figure	Quantity
Remote Controller Receiver		1
Pipe Clasp		1
Drain pipe accessories (sectional view)		1
Copper Nut (two specification)		2
Remote Controller		1
Dry Battery AAA		2
Installation & Owner' manual	/	1
Remote Controller Instruction	/	1

INSTALLATION OVERVIEW

1



Read The Safety Precaution

2



Install The Indoor Unit

3

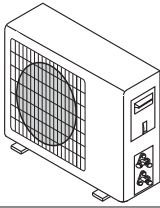

Install The Outdoor Unit

4

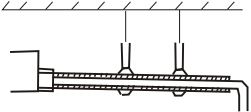

Install The Drainage Pipe

5

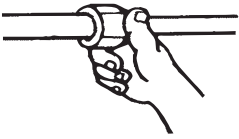

Install The Refrigerant Pipe

6

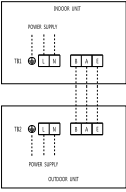

Electrical Wiring

8



Perform The Test Run

7

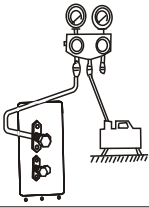

Air Evacuation

INDOOR UNIT INSTALLATION

Indoor Unit Parts

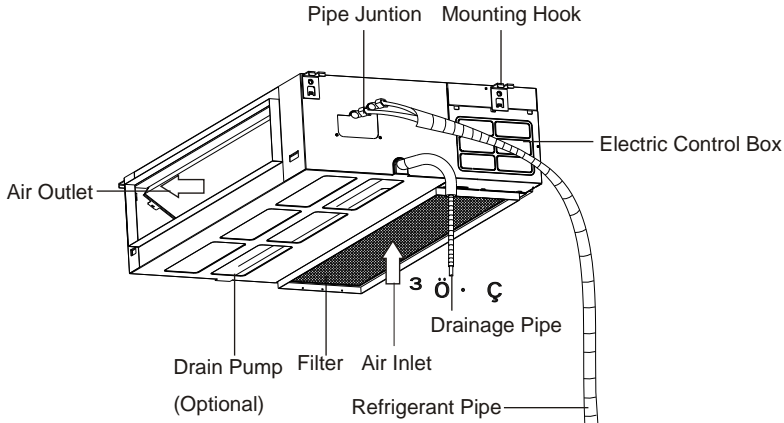

PRECAUTION

⚠ WARNING

- The indoor unit shall be firmly installed on the structure capable of bearing its weight. If the structure is too weak, the unit may fall and cause personal injury, property loss or death
- **DO NOT** install the indoor unit in the bathroom or laundry because too much moisture will short circuit the indoor unit and corrode the wiring.
- Install the indoor unit at a height of more than 2.5m (8') above the floor.

ⓘ CAUTION

- Install indoor and outdoor equipment, cables and wires at least 1 m (3.2 ') from TV and radio to prevent static electricity or image distortion. The distance can be increased appropriately according to different equipment
- If the indoor unit is installed on metal, it must be electrically grounded.

DO NOT install the unit in the following locations:

- ⊘ In areas with oil drilling or fracking
- ⊘ In coastal areas with high salt content in the air
- ⊘ In areas with caustic gases in the air, such as near hot springs
- ⊘ In areas with power fluctuations, such as factories
- ⊘ In enclosed spaces, such as cabinets
- ⊘ In kitchens that use natural gas
- ⊘ In areas with strong electromagnetic waves
- ⊘ In areas that store flammable materials or gas
- ⊘ In rooms with high humidity such as bathrooms or laundry rooms

Indoor Unit Installation Instructions

Select installation location

The indoor unit should be installed in a location that meets the following requirements:

- ☑ There is enough room for installation and maintenance.
- ☑ There is enough room for the connecting pipe and drainpipe.
- ☑ The ceiling is horizontal and its structure can sustain the weight of the indoor unit.
- ☑ The air inlet and outlet are not impeded.
- ☑ The airflow can fill the entire room.
- ☑ There is no direct radiation from heaters.

Body Dimension

1.The positioning of ceiling hole, indoor unit and hangingscrew bolts.

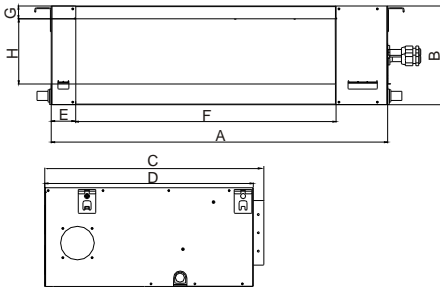

Air inlet size

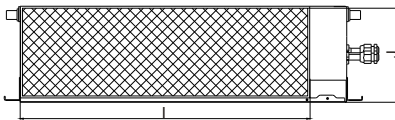

2.Position size of descensional ventilation opening.

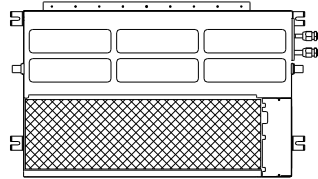

Size of mounted hook

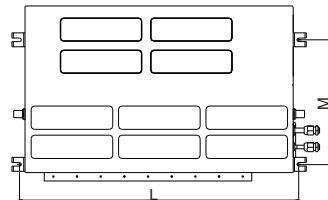

	Outline dimension				Air outlet opening size				Air return opening size			Size of mounted lug	
	A	B	C	D	E	F	G	H	I	J	K	L	M
18-24K	920	270	635	570	65	713	35	179	815	260	20	960	350
30K	1140	270	775	710	65	933	35	179	1035	260	45	1240	500
36-60K	1200	300	865	800	80	968	40	204	1094	268	45	1240	500

NOTE:All the figures in this manual are for explanation purpose only. They may be slightly different from the air conditioner you purchased. The actual unit shall prevail.

■ Choice of air return ways

- The air conditioner should be installed securely; otherwise poor installation may lead to abnormal noises and vibration.

This indoor unit is fitted with downward air return, which can be change to its backward counterpart if necessary. Please follow the steps below(2-5) to change it into the mode of air return backward(6).

1. Air return backward

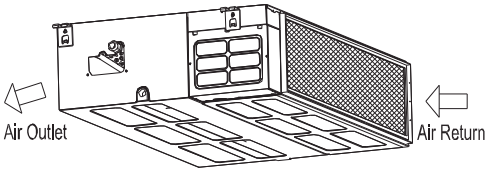

2. Install the flannel plate and filter at the backside; Install the cover to the downside.

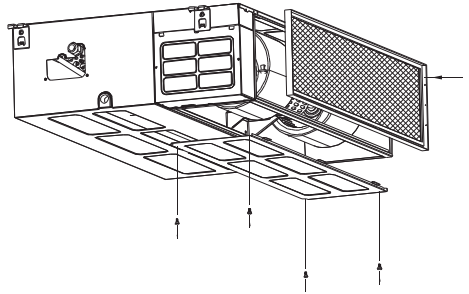

3. Loose the nut and dismantle flannel plate and filter; Loose the nutdismantel the back over.

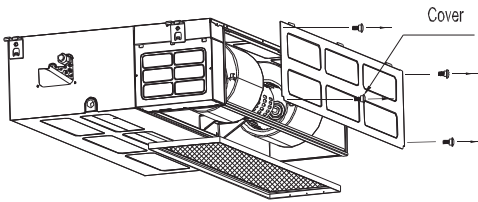

4. Air return downward

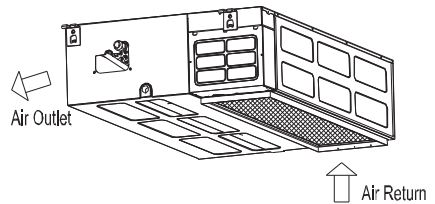

Hang Indoor Unit(For finished concrete bricks)

- 1、 Drill 4 holes 5cm (2") deep at the ceiling hook positions in the internal ceiling. Be sure to hold the drill at a 90° angle to the ceiling.
- 2、 Using a hammer, insert the ceiling hooks into the pre-drilled holes. Secure the bolt using the washers and nuts.
- 3、 Install the four suspension bolts.

For finished concrete bricks

Install the hanging hook with expansible bolt into the concrete deep to 45-50mm to prevent loose.

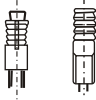

Wooden construction

Put the square timber over the roof beam, then install the hanging screw bolts.

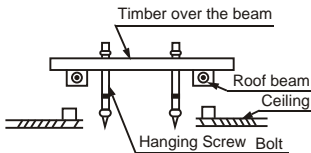

New Concrete Bricks

Inlaying or embedding the screw bolts.

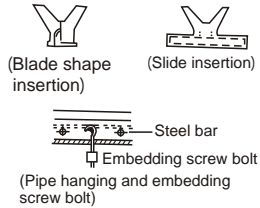

Steel roof beam structure

Install the supporting angle steel.

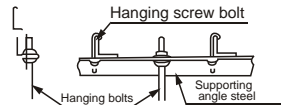

- 4、 Mount the indoor unit. You will need two people to lift and secure it. Insert suspension bolts into the units hanging holes. Fasten them using the washers and nuts.

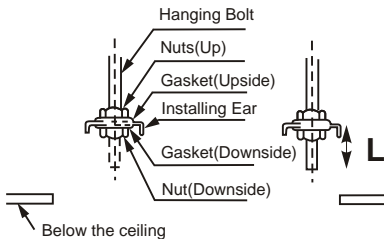

NOTE: L should be long enough to prevent the nuts from coming off

RECOMMENDED DISTANCES BETWEEN THE INDOOR UNIT AND THE CEILING

The distance between the mounted indoor unit and the internal ceiling should meet the following specifications.

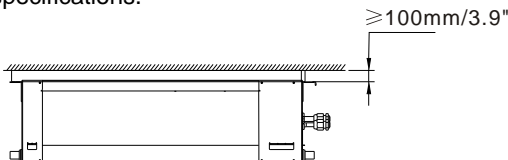

Outlet Air Pipe Installation

- Generally, we have two types of outlet pipe available, i.e. rectangular or round ones.
- Rectangular air conduit can be directly connected to air outlet of indoor unit by rivets. For outlet dimensions, see outline drawing of the unit.
- Round air conduit should be connected to a piece of transitional air conduit before it is connected to air outlet of indoor unit, the other end of it can be separately connected to air conduit window or connected to air conduit window after air flow diversion, and the total length should not be over 6m. As shown in figure below, air speeds at all air outlets should be set to basically consistent so as to meet the room air-conditioning requirements.

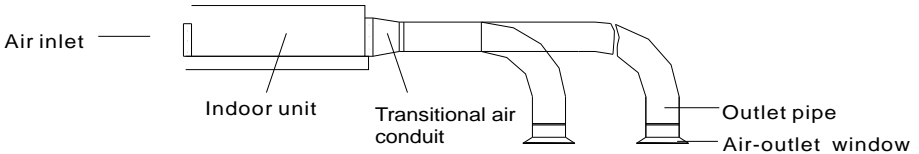

Return Air Pipe Installation

- In case sidewise air intake is adopted, return air pipe should be fabricated and rivet-connected to return air orifice, and the other end of it should be connected to return air window.
- In case of underside air intake, purchase or fabricate a section of pleated canvas air conduit serving as transition joint for return air orifice and return air window. in this way, it can be freely adjusted according to height of indoor ceiling board; in addition, during operation of the unit , canvas air conduit may avoid vibration of ceiling board, as shown in figure below.

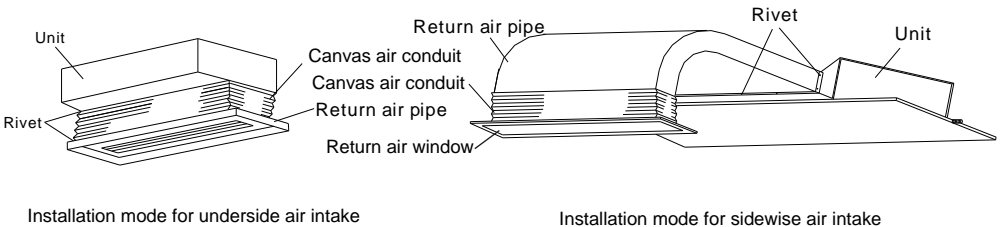

Tips for installation of return air pipe and outlet pipe

To minimize energy loss occurring in transmission process and condensed water during heating operation, return air pipe and outlet pipe should be equipped with heat-insulating layer as shown in the

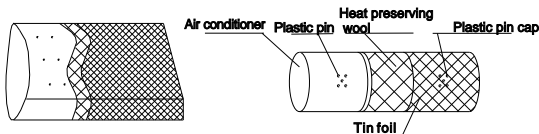

NOTE:Ensure sufficient space for installation and repair. (see the picture for details)

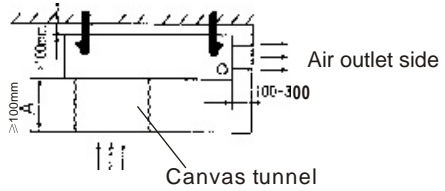

- Return air pipe and outlet pipe should be fixed to floor precast slabs by iron stand; in addition, all ports of the air conduit should be tightly sealed by gasket cement, and it is advisable that the edge clearance of return air pipe should be 150mm at least.
- Drain pipe for condensed water should be installed with minimum gradient of 1 %, and the drain pipe should be insulated with heat-preserving pipe casing as well.

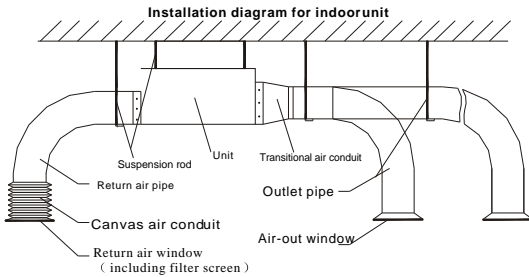

NOTE: Hang the nut inside the U slot of the installation panel. The unit should slope downward toward draining side at a gradient of about 1/100 to ensure smooth drainage.

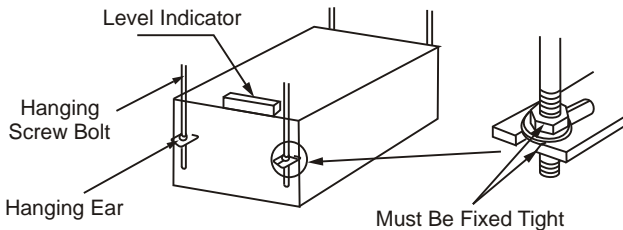

OUTDOOR UNIT INSTALLATION

Outdoor Unit Installation Instructions

Select installation location

The outdoor unit should be installed in a location that meets the following requirements:

- ☑ Keep the outdoor unit as close to the indoor unit as possible.
- ☑ Make sure there is enough space for installation and maintenance.
- ☑ The installation area must be dry and well ventilated.
- ☑ Make sure that the location of the unit is not affected by snow, leaf deposits or other seasonal debris. If possible, provide a awning for this unit. Make sure that the awning does not obstruct the air flow.
- ☑ There must be enough space to install connecting pipes and cables and access them for maintenance.
- ☑ The area must be free of combustible gases and chemicals. The length of pipeline between outdoor unit and indoor unit shall not exceed the maximum allowable pipeline length.
- ☑ If possible, do not install the unit in direct sunlight.
- ☑ If possible, make sure the device is away from the property of your neighbors so that the noise from the device does not interfere with them.
- ☑ Air inlet and air outlet shall not be blocked or exposed to strong wind. If the location is exposed to strong winds (for example, near the coast), you must place the unit against the wall to block the wind. If necessary, use a sunshade.
- ☑ Install indoor and outdoor equipment, cables and wires at least 1 meter away from TV or radio to prevent static electricity or image distortion. Depending on the radio waves, a distance of 1 meter may not be enough to eliminate all interference.

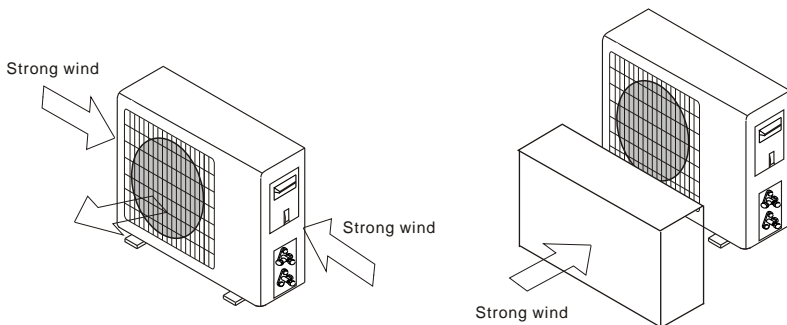

CAUTION

- Be sure to remove any obstacles that may block air circulation.
- Make sure you refer to Length Specifications to ensure there is enough room for installation and maintenance.

Body Dimensions

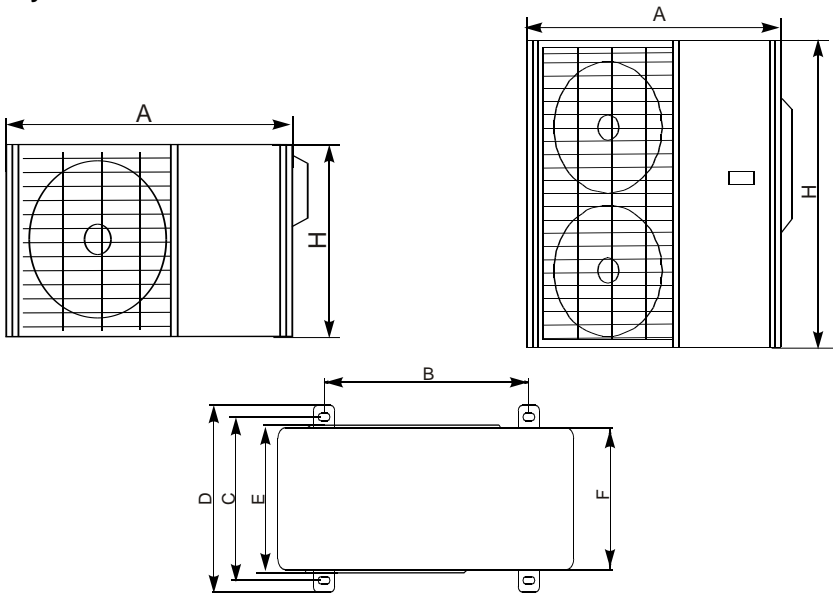

MODE	A	B	C	D	E	F	H
18-24K	845	586	347	372	342	330	700
30-42K	940	600	375	400	340	338	885
48-60K	950	600	375	409	354	352	1339

Install Outdoor Unit

Fix the outdoor unit with anchor bolts (M10)

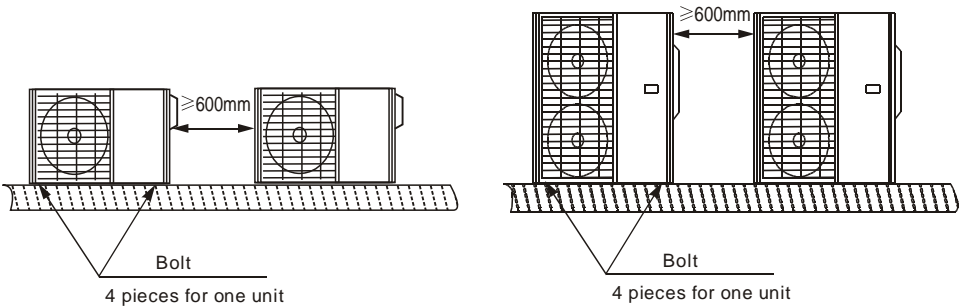

NOTE: The minimum distance between the outdoor unit and walls described in the installation guide does not apply to airtight rooms. Be sure to keep the unit unobstructed in at least two of the three directions (Front,Left,Right). (As shown on the right)

minimum space to be reserved (mm) showing in the picture

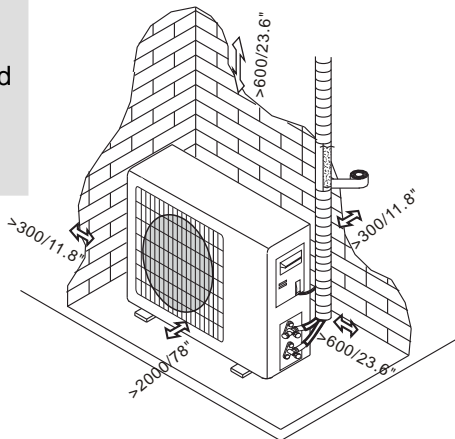

Outdoor unit condensed water drainage(Optional)

The condensed water and the ice formed in the outdoor unit during heating operation can be drained away through the drain pipe

1. Fasten the drain port in the 25mm hole placed in the part of the unit as shown in the picture.
 2. Connect the drain port and the drain pipe.
- Pay attention that water is drained in a suitable place.

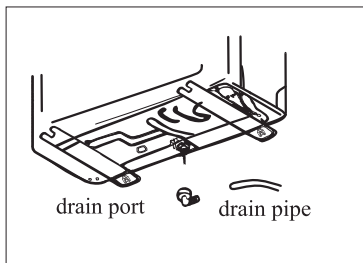

Drilling Hole In Wall

You must drill a hole in the wall for the refrigerant piping, and the signal cable that will connect the indoor and outdoor units.

1. Determine the location of the wall hole according to the location of the outdoor unit.
2. Use a 65 mm (2.5 ") core drill to drill holes in the wall.
3. Place the cuff on the hole. This protects the edge of the hole and helps seal the hole when the installation process is complete.

NOTE: When drilling the wall hole, make sure to avoid wires, plumbing, and other sensitive components.

DRAINPIPE INSTALLATION

CAUTION

- Insulate all piping to prevent condensation.
- **Do not** pull on the drain strongly, as this may cause it to disconnect.
- If the drain is bent or installed incorrectly, water may leak and cause the water level switch to fail. In heating mode, the outdoor unit will drain water.
- Make sure that the drain hose is placed in a suitable area to avoid water damage and slippage due to frozen drain water.
- The drainpipe is used to drain water. Improper installation may cause damage to equipment and property.

Indoor Drainpipe Installation

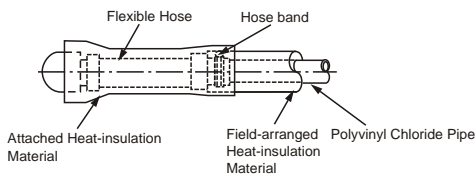
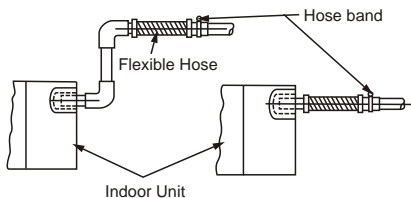

Install the drainpipe as shown below.

1. Attach the mouth of the drain hose to the unit's outlet pipe. Sheath the mouth of the hose and clip it firmly with a pipe clasp.
2. Cover the drainpipe with heat insulation to prevent condensation and leakage.

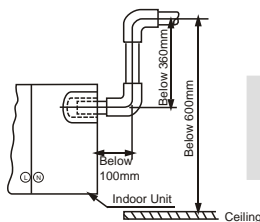
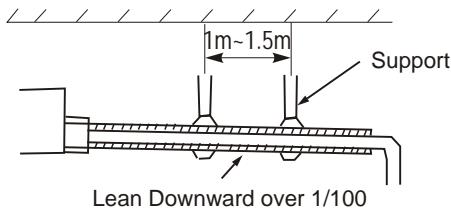

NOTE: Only for model with drain pump.

3. Using a 65-mm (2.5") core drill, drill a hole in the wall. Make sure that the hole is drilled at a slight downward angle, so that the outdoor end of the hole is lower than the indoor end by about 12mm (0.5") This will ensure proper water drainage (as shown). Place the protective wall cuff in the hole. This protects the edges of the hole and will help seal it when you finish the installation process.
4. Pass the drain hose through the wall hole. Make sure the water drains to a safe location where it will not cause water damage or a slipping hazard.

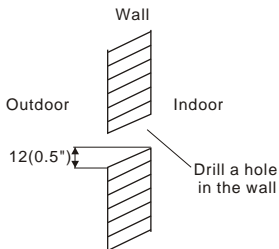

NOTE: When drilling the wall hole, make sure to avoid wires, plumbing, and other sensitive components. The drainpipe outlet should be at least 50mm (1.9") above the ground. If it touches the ground, the unit may become blocked and malfunction.

NOTE:

- When using an extended drain, use an additional protective tube to tighten the indoor connection to prevent it from loosening..
- The drain pipes shall be sloped down at least 1 / 100 to prevent water from flowing back to the air conditioner.
- In order to prevent pipe sagging, a support shall be set every 1-1.5m (40-59 ").
- If the outlet of the drainpipe is higher than the body's pump joint, provide a lift pipe for the exhaust outlet of the indoor unit. The lift pipe must be installed no higher than 360mm (14.2") from the exhaust outlet and the distance between the unit and the lift pipe must be less than 10mm (4").Improper installation may cause water to return to the unit and cause flooding.(Only for model with drain pump)

High static pressure drainage pipe installation

Warning:

Must install drainpipes according to the following figure ,avoiding generating condensed water and leakage water.

- Assemble the main body according to Figure .
- The opening of drainpipes can be installed on the left side or the right side . Could remove the drainstopper and put it on the left side or the right side.
- For the best effect, should keep pipes as short as possible. Tilt the pipes to ensure the flow of fluid.
- Make sure the drainpipes have admirable heat insulation.
- It is necessary to install a trap near the opening of the drainpipe, so that when the machine is working, the pressure in the inside of the machine is lower than atmospheric pressure. If there isn't a elbow , the water will splash and the pipe will produce a bad smell.
- keep straightness of drainpipes so as to remove dirt.
- Seal the drainpipe on the other side of the machine , then wrap up the drainpipe in the heat-barrier materials .
- Put water into the drain pan to test whether the water can be discharged swimmingly.
- In humid conditions , please must use a add-on drain pan (commercially available) to cover the whole area of the indoor unit.

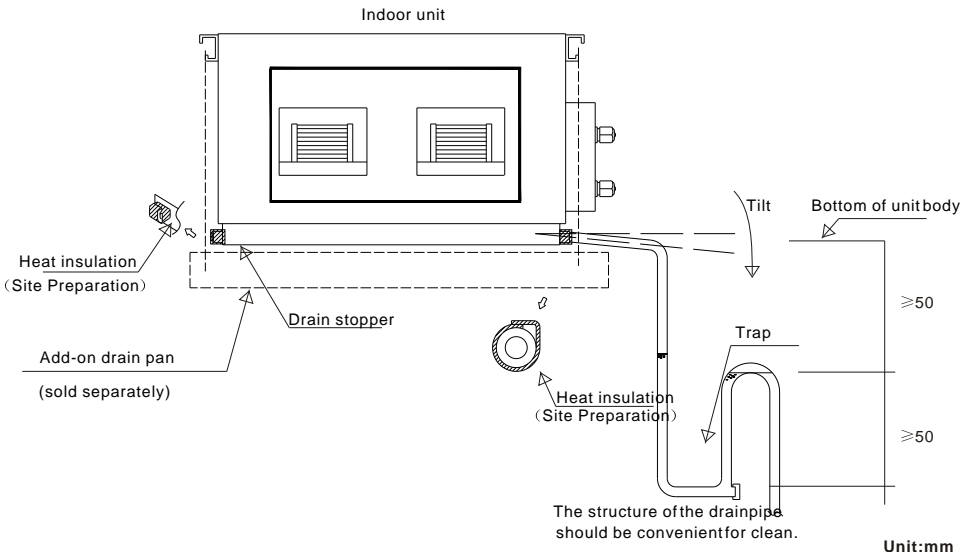

Refrigerant Piping Connection

SAFETY PRECAUTION

⚠ WARNING

- All field piping must be completed by certified technicians and must comply with local and national regulations.
- When installing the refrigeration system, ensure that air, dust, moisture or foreign substances do not enter the refrigerant circuit. Contamination in the system may cause poor operating capacity, high pressure in the refrigeration cycle, explosion or injury.
- When the air conditioner is installed in a small room, measures must be taken to prevent the refrigerant concentration in the room from exceeding the safety limit when the refrigerant leaks. If the refrigerant leaks and the concentration exceeds its appropriate limit, it may cause a risk of hypoxia.
- If refrigerant leaks during installation, ventilate the area immediately. The leaked refrigerant gas is toxic and flammable. After completing the installation work, make sure that there are no refrigerant leaks.
- The welding port of the connecting pipe of the internal and external machine must be located on the outdoor side.

Pipe dimension and ways of installation

Outdoor pipe dimension and ways of install (in sequence of cooling capacity)

Pipe Material		Copper Pipe for Air Conditioner		
Model		18k-24k	30k-42k	48k-60k
Size(mm)	Liquid side	φ6.35(1/4inch)	φ9.52(3/8inch)	φ9.52(3/8inch)
	Gas side	φ12.7(1/2inch)	φ15.8(5/8inch)	φ19.05(3/4inch)

NOTE: Ensure that the length of the refrigerant pipe, the number of bends, and the drop height between the indoor and outdoor units meets the requirements

The maximum length and drop height based on models. (Unit: m/ft.)

Conventional pipe, cooling capacity < 24KBtu/h		Allowed value
Longest pipe(L)		30/98.4
Maximum height drop	Height drop between indoor and outdoor unit	20/65.6

Conventional pipe, cooling capacity ≥ 24K - < 36KBtu/h		Allowed value
Longest pipe(L)		50/164
Maximum height drop	Height drop between indoor and outdoor unit	25/82

Conventional pipe, cooling capacity ≥ 36KBtu/h		Allowed value
Longest pipe (L)		65/213
Maximum height drop	Height drop between indoor and outdoor unit H	30/98.4

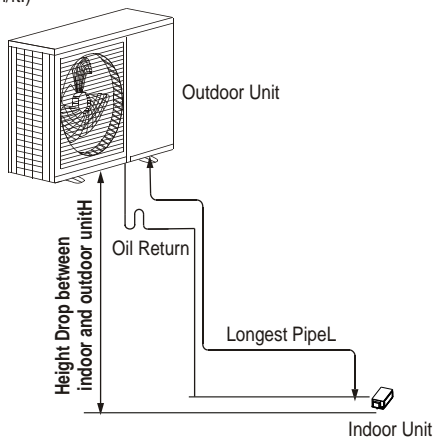

Oil Traps

CAUTION

1. If the indoor unit is installed higher than the outdoor unit:

If oil flows back into the outdoor unit's compressor, this might cause liquid compression or deterioration of oil return. Oil traps in the rising gas piping can prevent this. An oil trap should be installed every 10m (32.8ft) of vertical suction line riser.

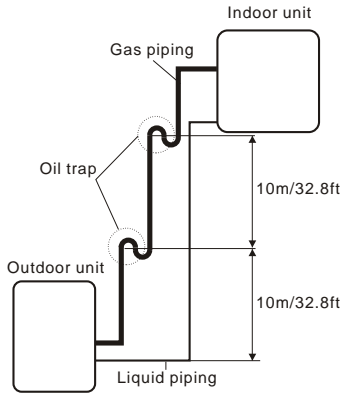

2. If the outdoor unit is installed higher than the indoor unit:

It is recommended that vertical suction risers not be upsized. Proper oil return to the compressor should be maintained with suction gas velocity. If velocities drop below 7.62m/s (1 500fpm (feet per minute)), oil return will be decreased. An oil trap should be installed every 6m (20ft) of vertical suction line riser.

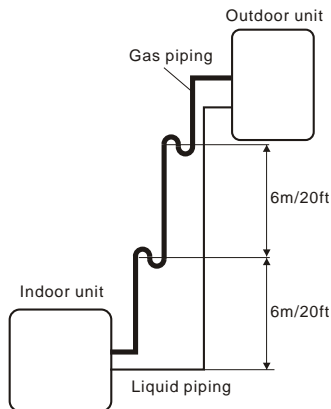

Refrigerant Piping Connection Instructions

CAUTION

- **DO NOT** install the connecting pipe until both indoor and outdoor units have been installed.
- Insulate both the gas and liquid piping to prevent water leakage.
- **DO NOT** deform pipe while cutting. Be extra carefull not to damage, dent, or deform the pipe while cutting. This will drastically reduce the heating efficiency of the unit

Cut pipes

When preparing refrigerant pipes, take extra care to cut and flare them properly. This will ensure efficient operation and minimize the need for future maintenance.

1. Measure the distance between the indoor and outdoor units.
2. Using a pipe cutter, cut the pipe a little longer than the measured distance.

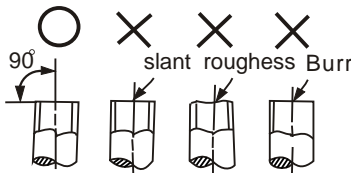

Remove burrs

Burrs can affect the air-tight seal of refrigerant piping connection. They must be completely removed.

1. Hold the pipe at a downward angle to prevent burrs from falling into the pipe.
2. Using a reamer or deburring tool, remove all burrs from the cut section of the pipe.

Flare pipe ends

Proper flaring is essential to achieve an airtight seal.

1. After removing burrs from cut pipe, seal the ends with PVC tape to prevent foreign materials from entering the pipe.
2. Sheath the pipe with insulating material.
3. Place flare nuts on both ends of pipe. Make sure they are facing in the right direction, because you can't put them on or change their direction after flaring.

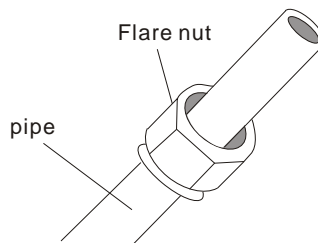
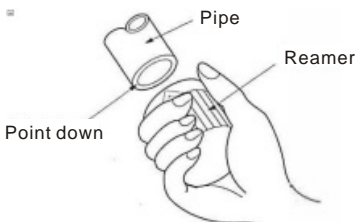

4. Remove PVC tape from ends of pipe when ready to perform flaring work.
5. Clamp flare form on the end of the pipe. The end of the pipe must extend beyond the flare form.
6. Place flaring tool onto the form.
7. Turn the handle of the flaring tool clockwise until the pipe is fully flared. Flare the pipe in accordance with the dimensions

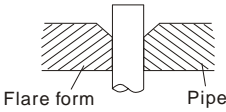

Outside Diameter	Tightening Torque	Flare dimension(A) (unit:mm/inch)	
Φ 7/16"	18-20N · m (183-204kgf.cm)	8.4/0.33	8.4/0.33
Φ 5/8"	25-26N · m (255-265kgf.cm)	13.2/0.52	13.5/0.53
Φ 3/4"	35-36N · m (357-367kgf.cm)	16.2/0.64	16.5/0.65
Φ 7/8"	45-47N · m (459-480kgf.cm)	19.2/0.76	19.7/0.78
Φ 17/16"	65-67N · m (765-867kgf.cm)	23.2/0.91	23.7/0.93

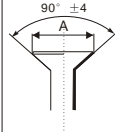

8. Remove the flaring tool and flare form, then inspect the end of the pipe for cracks and even flaring

NOTE: Connect the copper pipes to the indoor unit first, then connect it to the outdoor unit. You should first connect the low-pressure pipe, then the high-pressure pipe.

1. When connecting the flare nuts, apply a thin coat of refrigeration oil to the flared ends of the pipes.
2. Align the center of the two pipes that you will connect.
3. Tighten the flare nut as tightly as possible by hand.
4. Using a spanner, grip the nut on the unit tubing.

NOTE: Use two spanners to connect the pipe with indoor /outdoor pipes to avoid the copper pipe cracking.

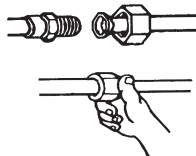

5. While firmly gripping the nut, use a torque wrench to tighten the flare nut according to the torque values.

ⓘ CAUTION

- Ensure to wrap insulation around the piping. Direct contact with the bare piping may result in burns or frostbite.
- Make sure the pipe is properly connected. Over tightening may damage the bell mouth and under tightening may lead to leakage.

6. After connecting the copper pipes to the indoor unit, wrap the power cable, signal cable and the piping together with binding tape.

NOTE: While bundling these items together, **DO NOT** intertwine or cross the signal cable with any other wiring.

Drain pipe outlet should be led to a place that can avoid affecting the environment.

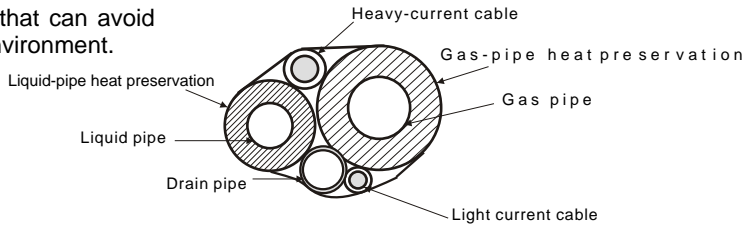

7. Thread this pipeline through the wall and connect it to the outdoor unit.
8. Insulate all the piping, including the valves of the outdoor unit.
9. Open the stop valves of the outdoor unit to start the flow of the refrigerant between the indoor and outdoor unit.

ⓘ CAUTION

- Check to make sure there is no refrigerant leak after completing the installation work. If there is a refrigerant leak, ventilate the area immediately and evacuate the system (refer to the Air Evacuation section of this manual).

ELECTRIC WIRING

SAFETY PRECAUTION

WARNING

- Always disconnect the power supply before working on the unit.
- All electrical wiring must be done according to local and national regulations.
- The wiring must be carried out by a certified technician. Improper connection may cause electrical failure, personal injury and fire.
- This unit must use independent circuit and single outlet. Please **DO NOT** plug other equipment or chargers into the same outlet. If the circuit capacity is insufficient or the electrical system fails, it will cause electric shock, fire, unit and property loss
- Connect the power cord to the terminal and secure it with the wiring clamp. Improper connections may cause fire
- Make sure all wiring is correct and the control box cover is installed correctly. Otherwise, may cause overheating at the connection points, fire, and electrical shock.
- Ensure that main supply connection is made through a switch that disconnects all poles, with contact gap of a least 3mm (0.118").
- **DO NOT** modify the length of the power cord or use an extension cord.

CAUTION

- Connect the outdoor wires before connecting the indoor wires.
- Be sure to ground the equipment. The grounding wire shall be away from gas pipeline, water pipe, lightning rod, telephone or other grounding wire. Improper grounding may cause electric shock
- **DO NOT** connect the unit with the power source until all wiring and piping is completed.
- Please make sure not to cross the wire with the signal wire, which will cause distortion and interference.
- The unit must be connected to the main outlet. Normally, the power supply must have a low output impedance of 32 ohms.
- No other equipment should be connected to the same power circuit.

NOTE:The type of fuse for controller of indoor unit is 50CT/524, rated specification is T 5A,250VAC.Fuse for the whole unit is not supplied by the manufacturer,so the installer must employ a suitable fuse or other over-current protective device for the power supply circuit according to the maximum power input as required.

Outdoor Unit Wiring

⚠ WARNING

- Please turn off the main power of the system before performing any electrical or wiring work.

⚠ CAUTION

- Please wire in strict accordance with the wiring diagram(found inside the electrical box cover).
- The refrigerant circuit can become very hot. Keep the interconnection cable away from the copper tube.

Prepare The Cable For Connection

- 1、 You must first choose the right cable size before preparing it for connection. Be sure to use H07RN-F cables.
- 2、 Using wire strippers, strip the rubber jacket from both ends of signal cable to reveal about 15cm (5.9") of the wires inside.
- 3、 Strip the insulation from the ends of the wires.
- 4、 Using a wire crimper, crimp u-lugs on the ends of the wires.

Minimum Cross-Sectional Area of Power and Signal Cables

Rated Current of Appliance(A)	AWG
≤7	18
7-13	16
13-18	14
18-25	12
25-30	10

North Americ

Rated Current of Appliance(A)	Nominal Cross-Sectional Area(mm ²)
≤6	0.75
6-10	1
10-16	1.5
16-25	2.5
25-32	4

Other Regions

Wiring Instructions

- 1、 Remove the electric cover of the outdoor unit.

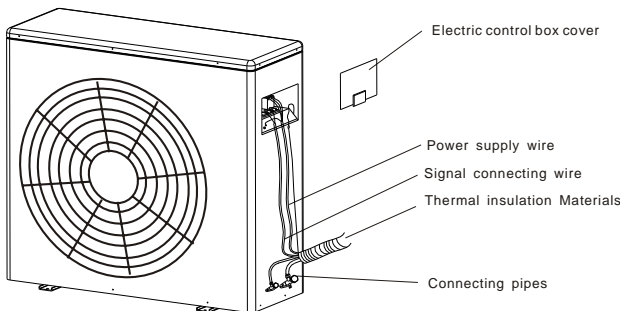

- 2、 Connect the power connection cord to the terminal board. Wiring should fit that of indoor unit.
- 3、 Fix the power connection cord with wire clamp.
- 4、 Confirm if the wire has been fixed properly.
- 5、 An efficient earth connection must be ensured.
- 6、 Recover the control box cover.

Indoor Unit Wiring

Prepare The Cable For Connection

- Using wire strippers, strip the rubber jacket from both ends of signal cable to reveal about 15cm (5.9") of the wires inside.
- Strip the insulation from the ends of the wires.
- Using a wire crimper, crimp u-lugs on the ends of the wires.

Wiring Instructions

- Remove the electric cover of the outdoor unit.
- Thread the power cable and the signal cable through the wire outlet rubber ring of the box

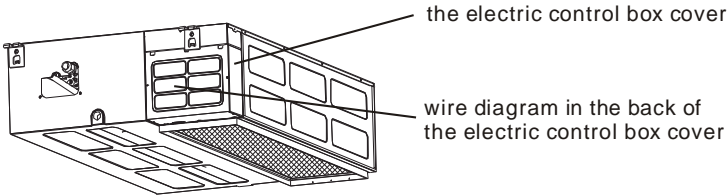

- Connect the power connection cord to the terminal board. Wiring should fit that of outdoor unit.
- Fix the power connection cord with wire clamp.
- Confirm if the wire has been fixed properly.
- An efficient earth connection must be ensured.
- Reinstall the electric cover of the indoor unit.
- Wrap the power cable, signal cable and the piping together with binding tape.

Wiring Diagram

1、 For 1Phase model

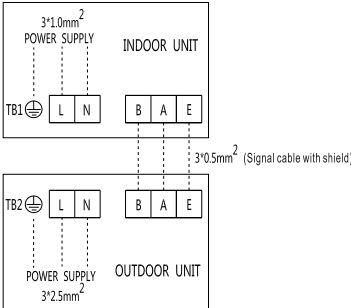

1、 For 3Phase model

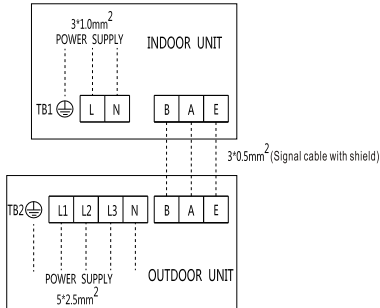

MODEL(Btu/h)		24K	30K	36K	36K	42K/48K/55K
POWER (indoor)	PHASE	1 Phase	1 Phase	1 Phase	1 Phase	1 Phase
	VOLT	220-240V 50Hz	220-240V 50Hz	220-240V 50Hz	220-240V 50Hz	220-240V 50Hz
Circuit Breaker/Fuse(A)		32/25	50/40	50/40	50/40	70/55
POWER (outdoor)	PHASE	1 Phase	1 Phase	1 Phase	3 Phase	3 Phase
	VOLT	220-240V 50Hz	220-240V 50Hz	220-240V 50Hz	380-415V 50Hz	380-415V 50Hz
Circuit Breaker/Fuse(A)		32/25	50/40	50/40	25/20	32/25

A/C Power Specification

AIR EVACUATION

Safety Precautions

CAUTION

- Use a vacuum pump with a gauge reading lower than -0.1 MPa and an air discharge capacity above 40L/min.
- The outdoor unit does not need vacuuming. **DO NOT** open the outdoor unit's gas and liquid stop valves.
- Ensure that the Compound Meter reads -0.1 MPa or below after 2 hours. If after three hours of operation and the gauge reading is still above -0.1 MPa, check if there is a gas leak or water inside the pipe. If there is no leakage, perform another evacuation for 1 or 2 hours.
- **DO NOT** use refrigerant gas to evacuate the system.

Evacuation Instructions

NOTE: Before using manifold pressure gauge and vacuum pump, please read their operating instructions and be familiar with how to use the manual correctly

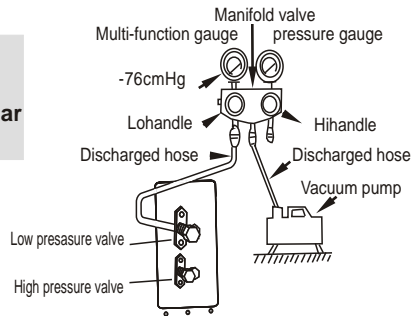

1. Connect the hose of manifold pressure gauge to the maintenance port on the low pressure valve of outdoor unit.
2. Connect another hose from manifold pressure gauge to vacuum pump.
3. Open the Low Pressure side of the manifold gauge. Keep the High Pressure side closed.
4. Turn on the vacuum pump to empty the gas in the system.
5. Run the vacuum pump for at least 15 minutes, or until the compound meter reads -76cmhg (-1 X105pa).
6. Close the low pressure side of the manifold pressure gauge and close the vacuum pump.
7. Wait for 5 minutes and check whether the system pressure changes.

NOTE: If there is no change in system pressure, unscrew the cap from the high pressure valve. If there is a change in system pressure, there may be a gas leak.

8. Insert a hex wrench into the high-pressure valve and open the valve by turning the wrench in a 1/4 counter clockwise turn. Listen for any gas coming out of the system and close the valve after 5 seconds.

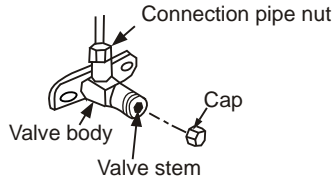

9. Observe the pressure gauge for one minute to make sure that the pressure does not change. The pressure gauge should read slightly above atmospheric pressure
10. Remove the charge hose from the service port.
11. Using hexagonal wrench, fully open both the high pressure and low pressure valves.
12. Tighten valve caps by hand, then tighten it using the proper tool.

ⓘ CAUTION

- When opening valve stems, turn the hexagonal wrench until it hits against the stopper. **DO NOT** try to force the valve to open further.

■ Additional Refrigerant Charge

⚠ CAUTION

- Refrigerant charging must be done after wiring, vacuuming and leak testing.
- **Do not** exceed the maximum allowed amount of refrigerant or overcharge the system. This will damage or affect the function of the device.
- Charging with mismatched refrigerant can cause an explosion or an accident. Make sure that a suitable refrigerant is used.
- The refrigerant container must be opened slowly. Always use guards when charging the system.
- **Do not** mix refrigerant types. For R290 or R32 refrigerant models, when adding refrigerant to the air conditioner, ensure the safety of the conditions in the area by controlling flammable materials.

Some systems require additional refrigerant charge depending on the length of the pipe. The standard pipe length of this air conditioner is 5 meters (16 feet). The following table can be used to calculate the additional refrigerant to be charged:

Liquid pipe diameter	φ 6.35(1/4")	φ 9.52(3/8")	φ 12.7(1/2")
Additional charge for 1m/ft pipe(R32)	12g/0.13oz	24g/0.26oz	40g/0.42oz
Additional charge for 1m/ft pipe(R410A)	15g/0.16oz	30g/0.32oz	65g/0.69oz

TEST RUN

■ Precaution

The test run needs to be performed after the entire system is completely installed. Before performing the test, please confirm the following points:

- a. The indoor unit and outdoor unit are installed correctly according to the instructions
- b. The electrical wiring is properly connected.
- c. Make sure there are no obstacles near the air conditioner. These obstacles may cause the air conditioner to malfunction or degrade performance.
- d. The refrigeration system has no leakage.
- e. The drain pipe has been installed as required

CAUTION

Failure to perform the test run may result in unit damage, property damage or even personal injury.

■ Test Run Instructions



1. Open both the liquid and gas stop valves.
2. Turn on the main power switch and allow the unit to warm up.
3. Set the air conditioner to COOL mode.
4. For the Indoor Unit
 - a. Ensure the remote control and its buttons work properly.
 - b. Double check to see if the room temperature is being registered correctly.
 - c. Ensure the indicators on the remote control and the remote controller receiver work properly.
 - d. Ensure the manual buttons on the indoor unit works properly.
 - e. Check to see that the drainage system is unimpeded and draining smoothly.
 - f. Ensure there is no vibration or abnormal noise during operation.
5. For the Outdoor Unit
 - a. Check to see if the refrigeration system is leaking.
 - b. Make sure there is no vibration or abnormal noise during operation.
 - c. Ensure the wind, noise, and water generated by the unit do not disturb your neighbors or pose a safety hazard.

NOTE: If the unit malfunctions or does not operate according to your expectations, please refer to the Troubleshooting section of the Owner's Manual before calling customer service.

OWNER'S MANUAL

SAFTY PRECAUTION

- Read the following " PRECAUTIONS" carefully before installation.
- The caution items stated here must be followed because these important contents are related to safety. The meaning of each indication used is as below.
Incorrect installation due to ignoring of the instruction will cause harm or damage, and the seriousness is classified by the following indications.

 WARNING	This indication shows the possibility of causing death or serious injury.
 CAUTION	This indication shows the possibility of causing injury or damage to properties only.

NOTE :

1. Injury means causing harmed, burned, electrical shocked, but not serious for hospitalization.
 2. Damage of property means disrepair of property, material.
- Carry out test running to confirm that no abnormality occurs after the installation. Then, explain to user the operation, care and maintenance as stated in instructions. Please remind the customer to keep the operating instructions for future reference.

WARNING

- After installation, ensure there are no refrigerant leaks and that the unit is operating properly. Refrigerant is both toxic and flammable and poses a serious health and safety risk.
- Install according to this installation instructions strictly. If installation is defective, it will cause water leakage, electrical shock or fire.
- Use the attached accessories parts and specified parts for installation. Otherwise, it will cause the set to fall, water leakage, fire or electrical shock.
- Install at a strong and firm location which is able to withstand the set's weight. If the strength is not enough or installation is not properly done, the set will drop and cause injury.
- For electrical work, follow the local national wiring standard, regulation and this installation instructions. An independent circuit and single outlet must be used. If electrical circuit capacity is not enough or defect found in electrical work, it will cause electrical shock or fire.
- When carrying out piping connection, take care not to let air or other substances other than the specified refrigerant go into refrigeration cycle. Otherwise, it will cause lower capacity, abnormal high pressure in the refrigeration cycle, explosion and injury.
- Engage dealer or specialist for installation. If installation done by user is defective, it will cause water leakage, electrical shock or fire.

WARNING

- The appliance disconnection must be incorporated with an all-pole disconnection device in the fixed wiring in accordance with the wiring rules.
- Any person who is involved with working on or breaking into the refrigerant circuit should hold a current valid certificate from an industry-accredited assessment authority, which authorises their competence to handle refrigerants safely in accordance with an industry recognised assessment specification.
- Servicing shall only be performed as recommended by the equipment manufacturer. Maintenance and repair requiring the assistance of other skilled personnel shall be carried out under the supervision of the person competent in the use of flammable refrigerants.
- The equipment shall be properly stored to prevent mechanical damage from occurring.
- Keep ventilation openings clear of obstruction.
- Grounding is necessary. It may cause electrical shock if grounding is not perfect.
- Do not install the unit at place where leakage of flammable gas may occur. In case gas leaks and accumulates at surrounding of the unit, it may cause fire.

NOTE: The following informations are required for the units adopt R32/R290 Refrigerant.

- The appliances shall be stored in the room without continuous working ignition source (for example: open flames, an operating gas appliance or an operating electric heater).
- Do not pierce or burn the appliances.
- Note that the refrigerant may be odorless.
- Compliance with national gas regulations shall be observed.
- Appliance shall be stored in a well-ventilated area with room size corresponding to the specified operation area.
- Appliance shall be installed, operated and stored in a room with a floor area larger than $X \text{ m}^2$, installation of pipe-work shall be kept to a minimum $X \text{ m}^2$ (Please see the following form). The appliance shall not be installed in an unventilated space, if that space is smaller than $X \text{ m}^2$ (Please see the following form). Spaces where refrigerant pipes shall be compliance with national gas regulations.

Model (Btu/h)	Amount of refrigerant to be charged(kg)	maximum installation height(m)	Minimum room area(m^2)
$\leq 24\text{K}$	≤ 2.0	2.2m	4
30K-36K	2.2-2.4	2.2m	4
$\geq 42\text{K}$	≥ 2.8	2.2m	5





! CAUTION

- Do not operate the air conditioner or remote control with wet hands. This may cause electric shock.
- When the wind deflector moves, do not touch the air outlet with your hands. Fingers may be pinched or the machine may be damaged.
- If the air conditioner is used with other heating equipment, please adequately ventilate to avoid insufficient oxygen in the room
- After prolonged use, please check the indoor unit for damage. If the indoor unit is aged or damaged, it may fall or cause personal injury.
- Do not expose heat-producing appliances to cold air or place them under the indoor unit. This may cause incomplete combustion or deformation of the unit due to the heat.
- Do not place items that might be affected by moisture damage under the indoor unit. Condensation can occur at a relative humidity of 80%.
- Do not check the equipment yourself. Please have it checked by an authorized dealer.
- Do not use air conditioners for preservation purposes (storage of food, plants, animals, art, etc.).
- Do not touch the evaporator coil inside the indoor unit. The evaporator coil is very sharp and may cause injury.
- Do not climb or place objects on top of the outdoor unit.
- Do not let children play with the air conditioner.

Note about Fluorinated Gasses

1. This air conditioner contains fluorinated gas. Refer to the relevant label of the unit itself for specific information on the type and quantity of gas.
2. The installation, repair, maintenance and repair of the device must be carried out by qualified technicians.
3. Unloading and recycling of air conditioner must be carried out by certified technicians.
4. The system must be checked for leaks at least every 12 months.
5. When checking the air conditioner for leakage, it is strongly recommended that all checks be recorded

Explanation of symbols displayed on the indoor unit or outdoor unit (applicable to the unit adopts R32/R290 Refrigerant only):

	WARNING	This symbol shows that this appliance uses a flammable refrigerant. If the refrigerant is leaked and exposed to an external ignition source, there is a risk of fire.
	CAUTION	This symbol shows that the operation manual should be read carefully.
	CAUTION	This symbol shows that a service personnel should be handling this equipment with reference to the installation manual.
	CAUTION	This symbol shows that information is available such as the operating manual or installation manual.

PARTS AND FUNCTIONS

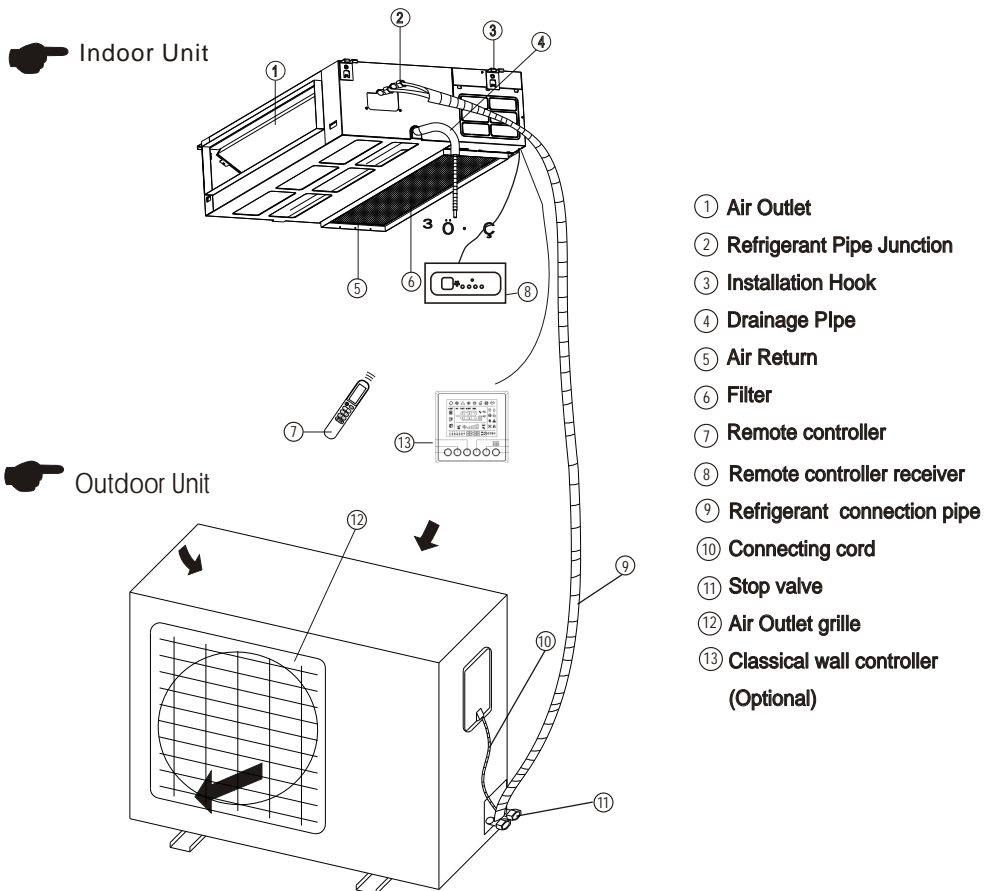

Requirements

- Notice that the air inlet/outlet must not be choked up. If chokeup takes place, the air conditioner behavior may be affected, or air conditioner cannot run because of actuation of protector.
- When outside temperature is below 0°C (32°F), we strongly recommend keeping the unit plugged in at all time to ensure smooth ongoing performance. (For outdoor unit to heat the crankcase of compressor.)

Operating condition

Use the air-conditioner under the following temperature:

MODE	Room Temperature	Outdoor Temperature
COOL mode	17°C-32°C (62°F-90°F)	-15°C-50°C (5°F-122°F)
HEAT mode	0°C-30°C (32°F-86°F)	-15°C-24°C (5°F-76°F)
DRY mode	17°C-32°C (62°F-90°F)	0°C-50°C (32°F-122°F)

If the air conditioner runs for a long time in "COOLING" or "DRY" mode at air relative humidity higher than 80% (doors or windows opened), dew may generate and drip near air outlet.

Noise pollution

- Install the air conditioner in a place that can bear its weight in order to operate more quietly.
- Install the outdoor unit in a place where the air discharged and the operation noise do not annoy your neighbors.
- Do not place any obstacles in front of the outlet of the outdoor unit for fear it affects operation and increases the noise level.

Features of Protector

- 1 The protective device will trip at following cases.
 - Stop the appliance and restart it at once or change other modes during operation, you have to wait 3 minutes before restarting.
 - After switching on the power circuit breaker and then turn on the air conditioner at once, you have to wait about 3 minute/20 seconds (some models).
- 2 In case all operations have stopped, you need
 - Press "ON/OFF" button again to restart it.
 - Set TIMER once again if it has been canceled.

Inspection

After a long time of operation, the air conditioner should be inspected for the following items.

- Abnormal heating of the power supply cord and plug or even a burnt smell.
- Abnormal operating noise or vibration.
- Water leakage from indoor unit.
- Metal cabinet electrified .
- ✎ Stop using the air conditioner if above problem happened.
It is advisable that the air conditioner should be given a detail check-up after using for five years even if none of the above happen.

Feature of HEATING mode

Preheat

2-5 minutes are necessary to preheat the indoor heat exchanger at the beginning of "HEATING" operation, lest cold air be discharged.

Defrost

In "HEATING" operation the appliance will defrost automatically. This procedure lasts 2~10 minutes, then returns to "HEATING" mode automatically. During defrosting, indoor fan stop running and return to heating mode operation automatically when defrosting has finished.

REMOTE CONTROLLER RECEIVER

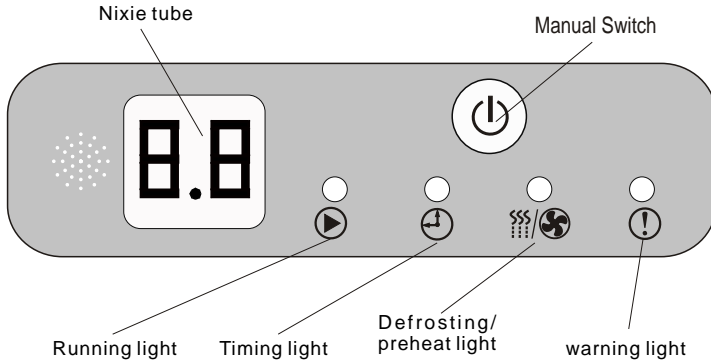

Display function declaration :

LED light the state of running light

When powered-on the first time, the running light twinkles, while the nixie tube does not lit.

When started-up normally, the running light lights on, while the nixie tube shows the designed temperature.

When operated normally, the running light lights on, while the nixie tube shows the designed temperature.

When closed down, both LED and nixie tube are gone out.

LED light the state of Timing light

When timing set, the timing light lights on, and the nixie tube flash shows the time setting within 5 seconds, then shows the designed temperature.

When without time setting, the timing light gone out, while the nixie tube back to the original state.

LED light the state of defrosting/preheat light

When in the state of defrost, oil return, cold-wind proof, the defrosting/preheat light lights on, while the nixie tube shows the designed temperature. (One-driven-one does not show the oil return state).

When out of the state of defrost, oil return, cold-wind proof, the defrosting/preheat light gone out, while the nixie tube shows the designed temperature. (One-drive-one dose no t show the oil return state).

LED light the state of warning light

When nixie tube shows E* or P*, the running lights gone out, while the warning light lights on.

2. Trouble display of outdoor unit

- (1) During standby, the digital tube displays the numbers of indoor unit currently connected and communicating.
- (2) When the compressor operates, the digital tube displays the frequency value of the inverter compressor;
- (3) The digital tube displays "dxx" during defrosting;
The digital tube displays "Cxx" during oil return
- (4) During trouble protection, the information code displayed by the digital tube.

MAINTAINANCE

SAFETY PRECAUTION

WARNING

- Make sure all wires are properly connected. Failure to connect the wires according to the instructions may result in electric shock or fire.
- Make sure to install the drain hose according to the instructions. Otherwise, it may cause leakage and cause personal and property damage
- Please contact an authorized service technician for repair or maintenance. Incorrect repairs and maintenance may cause water leakage, electric shock or fire.
- Please replace the blown fuse with a fuse of the specified specification, otherwise it may cause circuit damage or electrical fire.
- Do not disassemble or clean the filter yourself. Disassembly and maintenance must be performed by certified technicians.

CAUTION

- Always turn off your air conditioning system and disconnect the power supply before cleaning or maintenance.
- DO NOT use chemicals or chemically treated cloths to clean the unit.
- DO NOT use benzene, paint thinner, polishing powder or other solvents to clean the unit. They can cause the plastic surface to crack or deform.
- DO NOT wash the unit under running water. Doing so causes an electrical hazard.
- DO NOT use water hotter than 50°C (114°F) to clean the filter. This can cause the filter to become deformed or discolored. Clean the unit using a damp, lint-free cloth and neutral detergent. Dry the unit with a dry, lint-free cloth.

INDOOR UNIT MAINTANANCE INSTRUCTION

NOTE:The filter prevents dust and other particles from entering the indoor unit. Dust accumulation will reduce the efficiency of the air conditioner. For best efficiency, clean the air filter every two weeks. If you live in a dusty area, you should clean the air filter more frequently. If the filter is severely clogged and cannot be cleaned, replace it with a new filter.

- 1.Remove the air filter.
 - A.For your purchasing unit is a rear ventilated one(Fig A), please remove the filter fixed screws (2screws) and take down the filter a way from the unit.
 - B.For your purchasing unit is a descensional ventilated one(Fig B), please push the filter up slightly to let the position retainer escape away from the flange fixed holes, and take off the filter according to the arrow direction shows in the following fig B.
- 2.Clean the air filter by vacuuming the surface or washing it in warm water with mild detergent.
 - A.If using a vacuum cleaner, the inlet side should face the vacuum.
 - B. If using water,the inlet side should face down and away from the water stream.
- 3.Rinse the filter with clean water and allow it to air-dry. DO NOT let the filter dry in direct sunlight.
- 4.Reinstall the filter.

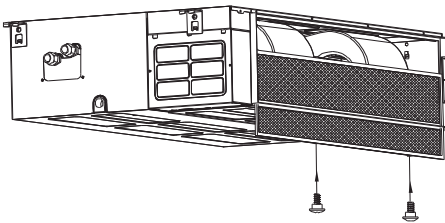

A

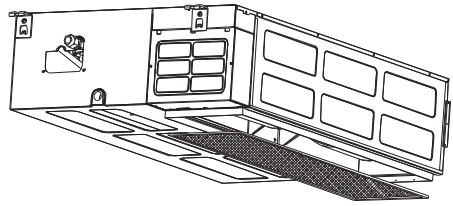

B

NOTE:For households with animals, you must wipe the grille regularly to prevent animal hair from obstructing the airflow.

■ PREPARATION FOR PERIODS OF NON-USE

Maintenance after Extended Non-Use

1. Remove all obstacles in front of the ventilation holes of indoor and outdoor units.
2. Clean the air filter of the indoor unit. Reinstall the filter to its original location.
3. Turn on the main power switch 12 hours before operating the equipment.

Storing the Unit While Not In Use

1. Run the product in fan mode for 12 hours in a warm room to dry it and prevent mold.
2. Turn off the power of the device and unplug the power plug.
3. Before storing, clean the air filter according to the instructions in the previous section.
4. Remove the battery from the remote control.

WARNING

- If the refrigerant leaks, turn off the air conditioner and any combustible heating devices, ventilate the room and call your dealer immediately.
- Refrigerant is both toxic and flammable. DO NOT use the air conditioner until the leak is repaired.
- When the air conditioner is installed in a small room, measures must be taken to prevent the refrigerant concentration from exceeding the safety limit in the event of refrigerant leakage. Concentrated refrigerant causes a severe health and safety threat.

TROUBLESHOOTING

⚠ CAUTION

If one of the following conditions occurs, switch off the power supply immediately and contact your dealer for further assistance :

- The operation light continues to flash rapidly after the unit has been restarted.
- The remote control buttons do not work.
- The unit continually trips fuses or circuit breakers.
- A foreign object or water enters the air conditioner.
- The indoor unit leaks.
- Other abnormal situations.

■ Common Problems

The following symptoms are not a malfunction and in most situations will not require repairs.

Problem	Possible Cause
Abnormal noises of indoor unit	When the system is turned off or in cooling mode, there will be abnormal noise, and when the drain pump (optional) is running, noise will also be heard.
	A squeaking sound may occur after running the unit in HEAT mode due to expansion and contraction of the unit's plastic parts.
Abnormal noises of outdoor unit	The unit will make different sounds based on its current operating mode.
Both the indoor and outdoor units makes noises	The air conditioner may sizzle during operation. This is a normal phenomenon, which is caused by refrigerant gas flowing through the indoor and outdoor units.
	When the air conditioner is turned on, and just stopped or defrosted, a hiss may be heard. This noise is normal and is caused by refrigerant gas stopping or turning.
Unit does not turn on when pressing ON/ OFF button	The unit has a 3-minute protection feature that prevents the unit from overloading. The unit cannot be restarted within three minutes of being turned off.
	Cooling and Heating Models: If the Operation light and PRE-DEF (Pre-heating/ Defrost) indicators are lit up, the outdoor temperature is too cold and the unit's anti-cold wind is activated in order to defrost the unit.
The unit changes from COOL mode to FAN mode	The unit changes its setting to prevent frost from forming on the unit. Once the temperature increases, the unit will start operating again.
	The set temperature has been reached, at which point the unit turns off the compressor. The unit will resume operating when the temperature fluctuates again.
The indoor unit emits white mist	In humid regions, a large temperature difference between the room's air and the conditioned air can cause white mist.

Problem	Possible Cause
Both the indoor and outdoor units emit white mist	When the unit restarts in HEAT mode after defrosting, white mist may be emitted due to moisture generated from the defrosting process.
Dust is emitted from either the indoor or outdoor unit	The unit may accumulate dust during extended periods of non-use, which will be emitted when the unit is turned on. This can be mitigated by covering the unit during long periods of inactivity.
The unit emits a bad odor	The unit may absorb odors from the environment (such as furniture, cooking, cigarettes, etc.) which will be emitted during operations.
	The unit filters have become moldy and should be cleaned.
The fan of the outdoor unit does not operate	During operation, the fan speed is controlled to optimize product operation.

■ Troubleshooting advices

When troubles occur, please check the following points before contacting a repair company.

Problem	Possible Cause	Solution
The unit is not working	Power failure	Wait for the power to be restored
	The power switch is off	Turn on the power
	The fuse is burned out	Replace the fuse
	Remote control batteries are dead	Replace the remote control batteries
	The unit's 3 minute protection has been activated	Wait three minutes after restarting the unit
Poor cooling performance	Temperature setting may be higher than the ambient room temperature	Lower the temperature setting
	The heat exchanger on the indoor or outdoor unit is dirty	Clean the affected heat exchanger
	The air filter is dirty	Remove the filter and clean it according to instructions
	The air inlet or outlet of either unit is blocked	Turn the unit off, remove the obstruction and turn it back on
	Doors and windows are open	Make sure that all doors and windows are closed while operating the unit
	Excessive heat is generated by sunlight	Close windows and curtains during periods of high heat or bright sunshine
	Low refrigerant due to leak or long-term use	Check for leaks, re-seal if necessary and top off refrigerant

Problem	Possible Cause	Solution
The unit starts and stops frequently	There's too much or too little refrigerant in the system	Check for leaks and recharge the system with refrigerant
	There is air, incompressible gas or foreign material in the refrigeration system.	Evacuate and recharge the system with refrigerant
	System circuit is blocked	Determine which circuit is blocked and replace the malfunctioning piece of equipment
	The compressor is broken	Replace the compressor
	The voltage is too high or too low	Install a manostat to regulate the voltage
Poor heating performance	The outdoor temperature is lower than 7°C (44.5°F)	Check for leaks and recharge the system with refrigerant
	Cold air is entering through doors and windows	Make sure that all doors and windows are closed during use
	Low refrigerant due to leak or long-term use	Check for leaks, re-seal if necessary and top off refrigerant

■ Error Code

The display content of indoor LED	The definition of failure or protection
E0	The indoor-outdoor communication goes wrong.
E1	The Room Temperature Sensor T1 goes wrong.
E2	The Internal Coil Temperature sensor T2 goes wrong.
E3	The External Temperature Sensor T3 goes wrong.
E4	The outdoor unit goes wrong.
E5	The model configuration processing (frequency conversion) goes wrong.
E6	The indoor fan goes wrong and/or the communication between the indoor DC fan and the indoor main control panel goes wrong.
E7	The Outdoor Temperature Sensor T4 goes wrong.
E8	The exhaust temperature sensor (TP1 of variable-frequency compressor) goes wrong
E9	The variable-frequency module goes wrong.
EC	The outdoor communication goes wrong.
EE	The EEPROM goes wrong (The E2 of the outdoor unit goes wrong).

The display content of indoor LED	The definition of failure or protection
EF	The outdoor fan goes wrong.
Ed	The EEPROM of main control panel goes wrong (The E2 of the indoor unit goes wrong)
d3	Water full protection
C5	The communication between the indoor unit and the wire controller goes wrong.
P0	Module protection
P1	Over/Under-voltage protection
P2	Over-current protection (Variable-frequency compressor)
P3	Outdoor unit protection
P4	Exhaust high-temperature protection (Variable-frequency compressor or Slave F3)
P5	Under-cooling protection in the cooling mode (Indoor unit coil temperature protection)
P6	Over-heating protection in the cooling mode (Condenser high-temperature protection)
P7	Over-heating protection in the heating mode (Indoor unit coil temperature protection)
P8	Outdoor high/low-temperature protection
P9	Drive protection (load abnormal)
PA	The modes conflict and the top air-out board communication goes wrong.
PH	Exhaust temperature sensor failure protection of outdoor unit
PC	Coil temperature sensor failure protection of outdoor unit
H1	High pressure switch protection
H2	Low pressure switch protection
H6	Insufficient of refrigerant protection
HE	Phase sequence protection

DISPOSAL GUIDELINE

This appliance contains refrigerant and other potentially hazardous materials. When disposing of this appliance, the law requires special collection and treatment. **DO NOT** dispose of this product as household waste or unsorted municipal waste.

When disposing of this appliance, you have the following options:

- Dispose of the appliance at designated municipal electronic waste collection facility.
- When buying a new appliance, the retailer will take back the old appliance free of charge.
- The manufacturer will also take back the old appliance free of charge.
- Sell the appliance to certified scrap metal dealers.
- Disposing of this appliance in the forest or other natural surroundings endangers your health and is bad for the environment. Hazardous substances may leak into the ground water and enter the food chain.



Information Servicing

1. Safety Checks

Before starting work on systems containing flammable refrigerants, a safety check must be carried out to ensure that the risk of fire is minimized. Before servicing the refrigeration system, observe the following precautions.

2. Work procedure

Work should be carried out in accordance with specified procedures to minimize the risk of flammable gas leakage.

3. Work area

All maintenance staff and others working in the local area shall be instructed on the nature of work being carried out. Work in confined spaces shall be avoided. The area around the work space shall be sectioned off. Ensure that the conditions within the area have been made safe by control of flammable material.

4. Refrigerant leakage check

Before and during work, the area should be checked with an appropriate refrigerant detector to ensure that technicians understand the concentration of flammable gases. The leak detection equipment used must match the flammable refrigerant.

5. Fire extinguisher preparation

If the refrigeration equipment or any related parts are to be operated at high temperature, dry powder or carbon dioxide fire extinguishers should be equipped.

6. Keep away from ignition sources

Anyone engaged in work related to refrigeration systems containing flammable refrigerants shall not use any ignition source. Any ignition source, including smoking, shall be kept away from the place of installation and maintenance. Failure to do so may result in danger to life or property damage.

7. Ventilation

Make sure the area is open or well ventilated before entering the system or carrying out any hot work. During piping work, a certain degree of ventilation shall be maintained. Ventilation should safely disperse the released refrigerant, preferably from the outside to the atmosphere.

8. Checks to the refrigeration equipment

When changing electrical components, they should be suitable for their purpose and meet the correct specifications. The manufacturer's maintenance and service guidelines should always be followed. If in doubt, please consult the manufacturer's technical department for assistance. For devices using flammable refrigerants, the following checks should be performed:

- The charge size is in accordance with the room size within which the refrigerant containing parts are installed;
- Ventilation machinery and vents are operating normally without obstruction;
- If you use an indirect refrigeration circuit, you should check whether there is refrigerant in the secondary circuit; the mark on the equipment is still clearly visible.
- Indistinct marks and signs should be corrected;
- The installation location of refrigeration pipes or components should make it not easy to be exposed to any environment that may corrode refrigerant-containing substances, unless these components are made of inherently anti-corrosion materials or are properly anti-corrosive.

9. Checks to electrical devices

The repair and maintenance of electrical components shall include preliminary safety inspection and component inspection procedures. If there are faults that may endanger safety, do not connect any power source to the circuit until the circuit is satisfactorily handled. If the failure cannot be corrected immediately, but it is necessary to continue the operation, an appropriate temporary solution should be used. This should be reported to the equipment manufacturer in order to inform the parties

Initial safety checks shall include:

- that capacitors are discharged: this shall be done in a safe manner to avoid possibility of sparking
- that there no live electrical components and wiring are exposed while charging, recovering or purging the system;
- that there is continuity of earth bonding

10. Sealed components maintenance

10.1 During repairs to sealed components, all electrical supplies shall be disconnected from the equipment being worked upon prior to any removal of sealed covers, etc. If it is absolutely necessary to have an electrical supply to equipment during servicing, then a permanently operating form of leak detection shall be located at the most critical point to warn of a potentially hazardous situation.

10.2 Particular attention shall be paid to the following to ensure that by working on electrical components, the casing is not altered in such a way that the level of protection is affected. This shall include damage to cable, excessive number of connections, terminals not made to Original specification, damage to seals, incorrect fitting of glands, etc.

- Ensure that apparatus is mounted securely
- Ensure that seals or sealing materials have not degraded such that they no longer serve the purpose of preventing the ingress of flammable atmospheres. Replacement parts shall be in accordance with the manufacturer s specifications.

11.Safe components

Do not impose any permanent inductive or capacitive load on the circuit unless it is ensured that it will not exceed the voltage and current allowed by the equipment in use. This machine safety component is the only type that can be operated in the presence of flammable gases. The test instrument should have the correct rating. Replace components only with parts specified by the manufacturer.

12.Cabling mantainence

Check the cable for wear, corrosion, excessive pressure, vibration, sharp edges, or any other adverse environmental effects. The inspection should also take into account the effects of aging or continuous vibration such as compressors or fans.

13.Detection of flammable refrigerants

Under no circumstances shall potential sources of ignition be used in the searching for Or detection of refrigerant leals.

For systems containing flammable refrigerants, the following leak detection methods are considered acceptable. An electronic leak detector should be used to detect flammable refrigerants, but the sensitivity may be insufficient or may require recalibration. (The testing equipment should be calibrated in an area free of refrigerant.) Make sure that the tester is suitable for the refrigerant. Leak detection equipment should be set as a percentage of the refrigerant LFL, and should be calibrated for the refrigerant used, and confirm the appropriate percentage of gas (maximum 25%). Leak detection fluids are suitable for most refrigerants, but the use of chlorine-containing cleaning agents should be avoided because chlorine may react with the refrigerant and corrode the copper pipes. If a leak is suspected, all open flames should be cleared or extinguished. If it is found that the refrigerant that needs to be brazed leaks, all the refrigerant should be recovered from the system, or be isolated in the system part away from the leakage through the shut-off valve.

15. Air evacuation

When breaking into the refrigerant circuit to make repairs or for any other purpose conventional procedures shall be used. However, it is important that best practice is followed since flammability is a consideration. The following procedure shall be adhered to:

- remove refrigerant;
- purge the circuit with inert gas;
- evacuate;
- purge again with inert gas;
- open the circuit by cutting or brazing.

The refrigerant should be recovered in the correct recovery cylinder. OFN should be used to flush the system to ensure the safety of the equipment. This process may need to be repeated several times. Compressed air or oxygen cannot be used for this task.

The refrigerant should be recovered in the correct recovery cylinder. OFN should be used to flush the system to ensure the safety of the equipment. This process may need to be repeated several times. Compressed air or oxygen cannot be used for this task. Flushing should be achieved by using OFN to break the vacuum in the system and continue to fill until the working pressure is reached, then evacuate to atmosphere and finally drop to vacuum. This process should be repeated until there is no refrigerant in the system. When using the final OFN charge, the system should be vented to atmospheric pressure for operation. If you want to braze the pipe, this operation is very important. Ensure that the outlet of the vacuum pump does not turn off any ignition source, and there is a ventilation device.

16. Refrigerant charging

In addition to following the normal charging procedure, the following requirements should also be followed:

- When using refrigerant charging equipment, please ensure that different refrigerants will not be contaminated. The hose or pipeline should be as short as possible to minimize the refrigerant content.
- Refrigerant tank should be kept upright.
- Before charging the refrigerant system, make sure it is grounded.
- Mark the system when the charge is complete.
- Be extra careful to avoid overfilling the refrigeration system.
- Prior to recharging the system it shall be pressure tested with OFN. The system shall be leak tested on completion of charging but prior to commissioning. A follow up leak test shall be carried out prior to leaving the site.

17. About air conditioner removal

Before performing this step, please confirm that the technician is fully familiar with the equipment and has relevant qualifications. It is recommended to safely recycle all refrigerants. Before completing the task, oil and refrigerant samples should be collected. Before the task begins, the power must be disconnected.

- a) Become familiar with the equipment and its operation.
- b) Isolate system electrically
- c) Before attempting the procedure ensure that:
 - mechanical handling equipment is available, if required, for handling refrigerant cylinders.
 - all personal protective equipment is available and being used correctly;
 - the recovery process is supervised at all times by a competent person;
 - recovery equipment and cylinders conform to the appropriate standards.
- d) Pump down refrigerant system, if possible.
- e) If a vacuum is not possible, make a manifold so that refrigerant can be removed from various parts of the system.
- f) Make sure that cylinder is situated on the scales before recovery takes place.
- g) Start the recovery machine and operate in accordance with manufacturer's instructions.
- h) Do not overfill cylinders. (No more than 80% volume liquid charge).

- i) Do not exceed the maximum working pressure of the cylinder, even temporarily.
- j) When the cylinders have been filled correctly and the process completed, make sure that the cylinders and the equipment are removed from site promptly and all isolation valves on the equipment are closed off.
- k) Recovered refrigerant shall not be charged into another refrigeration system unless it has been cleaned and checked.

18. Labelling

Equipment shall be labelled stating that it has been de-commissioned and emptied of refrigerant. The label shall be dated and signed. Ensure that there are labels on the equipment stating the equipment contains flammable refrigerant.

19. Refrigerant recovery

- When removing refrigerant from a system, either for service or decommissioning, it is recommended good practice that all refrigerants are removed safely.
- When transferring refrigerant into cylinders, ensure that only appropriate refrigerant recovery cylinders are employed. Ensure that the correct numbers of cylinders for holding the total system charge are available. All cylinders to be used are designated for the recovered refrigerant and labelled for that refrigerant (i.e special cylinders for the recovery of refrigerant). Cylinders shall be complete with pressure relief valve and associated shut-off valves in good working order
- Empty recovery cylinders are evacuated and, if possible, cooled before recovery occurs.
- The recovery equipment shall be in good working order with a set of instructions concerning the equipment that is at hand and shall be suitable for the recovery of flammable refrigerants. In addition, a set of calibrated weighing scales shall be available
- and in good working order.
- Hoses shall be complete with leak-free disconnect couplings and in good condition. Before using the recovery machine, check that it is in satisfactory working order, has been properly maintained and that any associated electrical components are sealed to prevent ignition in the event of a refrigerant release. Consult manufacturer if in doubt.
- The recovered refrigerant shall be returned to the refrigerant supplier in the correct recovery cylinder, and the relevant Waste Transfer Note arranged. Do not mix refrigerants in recovery units and especially not in cylinders.
- If compressors or compressor oils are to be removed, ensure that they have been evacuated to an acceptable level to make certain that flammable refrigerant does not remain within the lubricant. The evacuation process shall be carried out prior to re-tuning the compressor to the suppliers. Only electric heating to the compressor body shall be employed to accelerate this process. When oil is drained from a system, it shall be carried out safely.

20. Transportation, marking and storage for units

1. Transport of equipment containing flammable refrigerants
Compliance with the transport regulations
2. Marking of equipment using signs
Compliance with local regulations
3. Disposal of equipment using flammable refrigerants
Compliance with national regulations
4. Storage of equipment/appliances
The storage of equipment should be in accordance with the manufacturer's instructions.
5. Storage of packed (unsold) equipment
Storage package protection should be constructed such that mechanical damage to the equipment inside the package will not cause a leak of the refrigerant charge. The maximum number of pieces of equipment permitted to be stored together will be determined by local regulations.

In line with the company's policy of continual product improvement, the aesthetic and dimensional characteristics, technical data and accessories of this appliance may be changed without notice.

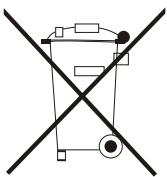

**IMPORTANT INFORMATION FOR CORRECT DISPOSAL OF THE PRODUCT
IN ACCORDANCE WITH EC DIRECTIVE 2002/96/EC.**

At the end of its working life, the product must not be disposed of as urban waste. It must be taken to a special local authority differentiated waste collection centre or to a dealer providing this service.

Disposing of a household appliance separately avoids possible negative consequences for the environment and health deriving from inappropriate disposal and enables the constituent materials to be recovered to obtain significant savings in energy and resources. As a reminder of the need to dispose of household appliances separately, the product is marked with a crossed-out wheeled dustbin.